

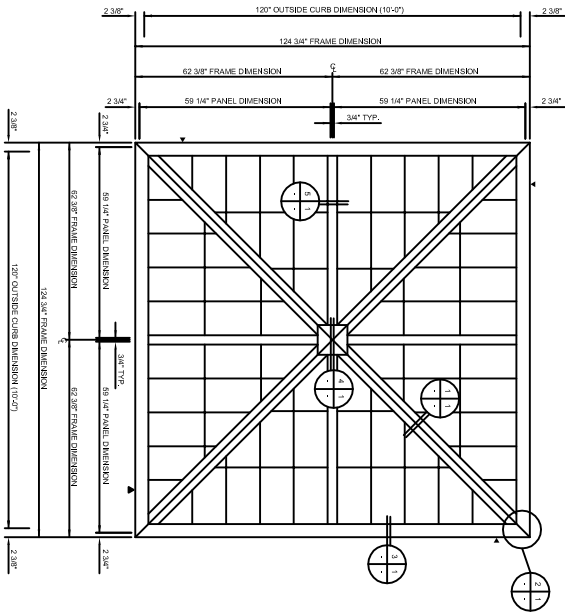

QUICKSHIP 10 FT - 26 1/2° PYRAMID



GUARDIAN 275
QUICKSHIP PYRAMID
TRANSLUCENT PANEL
SKYLIGHT SYSTEM



MATING BAR DETAIL
SCALE: NTS

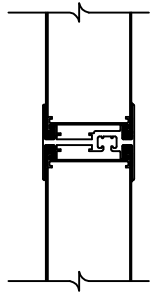

HIP DETAIL
SCALE: NTS

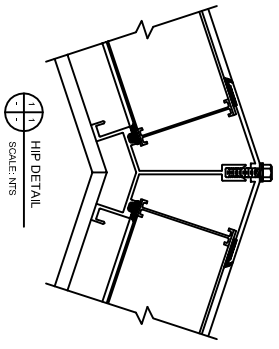

HIP CONNECTION
SCALE: NTS

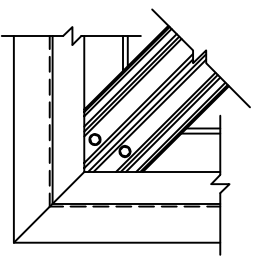

COMPRESSION CONNECTION
SCALE: NTS

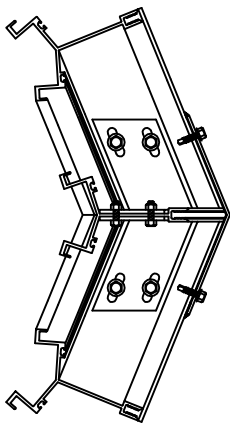

CURB DETAIL
SCALE: NTS

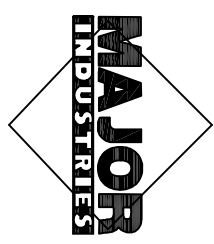
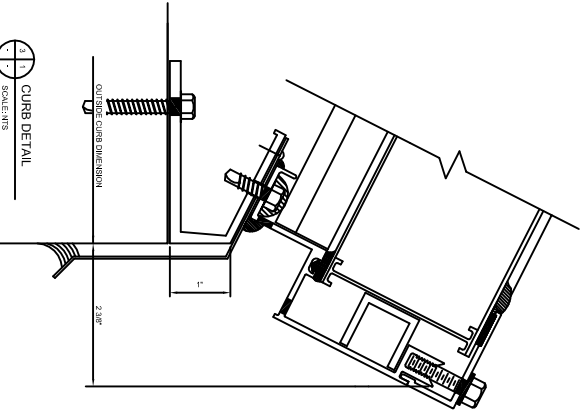

GUARDIAN 275®
TRANSLUCENT PANEL
SKYLIGHT SYSTEM

UNIT IS PICTURED
WITH STANDARD
GRID CORE.

THERMALLY BROKEN
OPTION IS NOT
SHOWN.

QS10-612PKD

MAJOR INDUSTRIES, INC.

7120 STEWART AVENUE
WAUSAU, WI 54401
PO BOX 306
WAUSAU, WI 54402-0306

TELEPHONE:
(715) 842-4616

ENGINEERING FAX:
(715) 843-5139

QUICKSHIP

10'-0" - 26 1/2° PYRAMID