

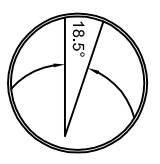

QUICKSHIP 4 FT - 18 1/2° PYRAMID

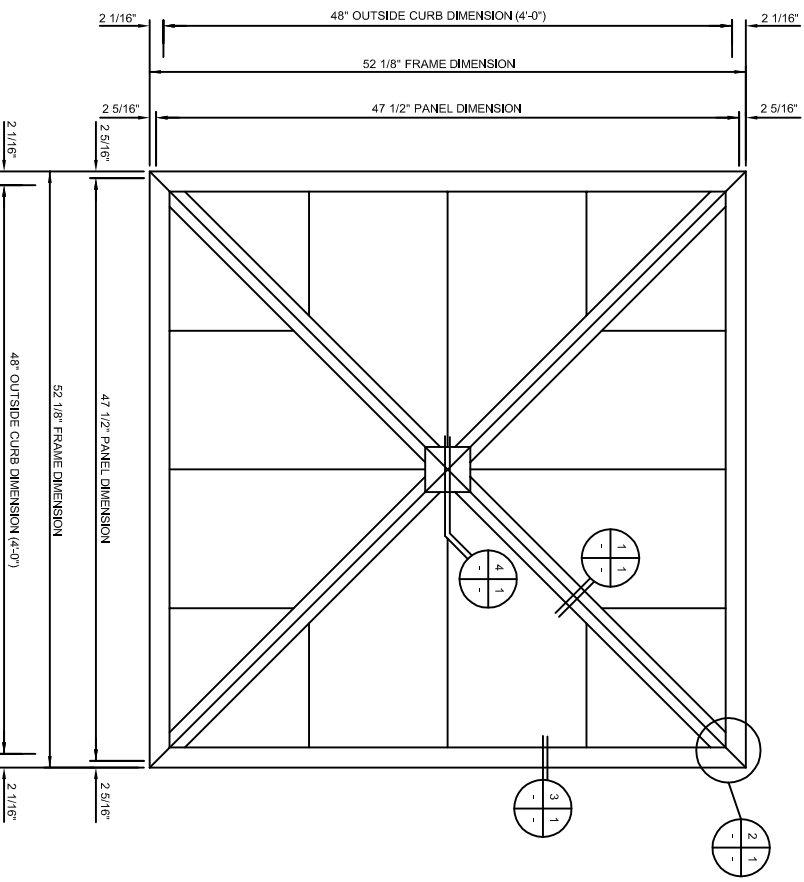

GUARDIAN 275
 QUICKSHIP PYRAMID
 TRANSLUCENT PANEL
 SKYLIGHT SYSTEM

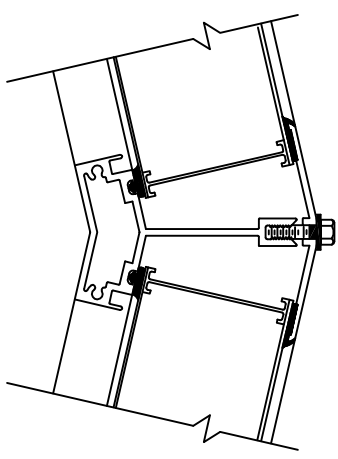

1
 HIP DETAIL
 SCALE: NTS

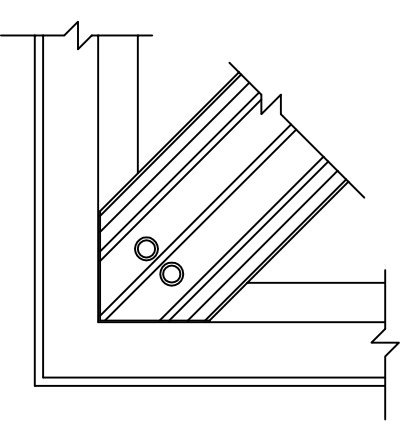

2
 HIP CONNECTION
 SCALE: NTS

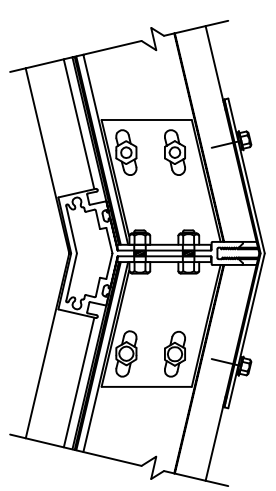

4
 COMPRESSION CONNECTION
 SCALE: NTS

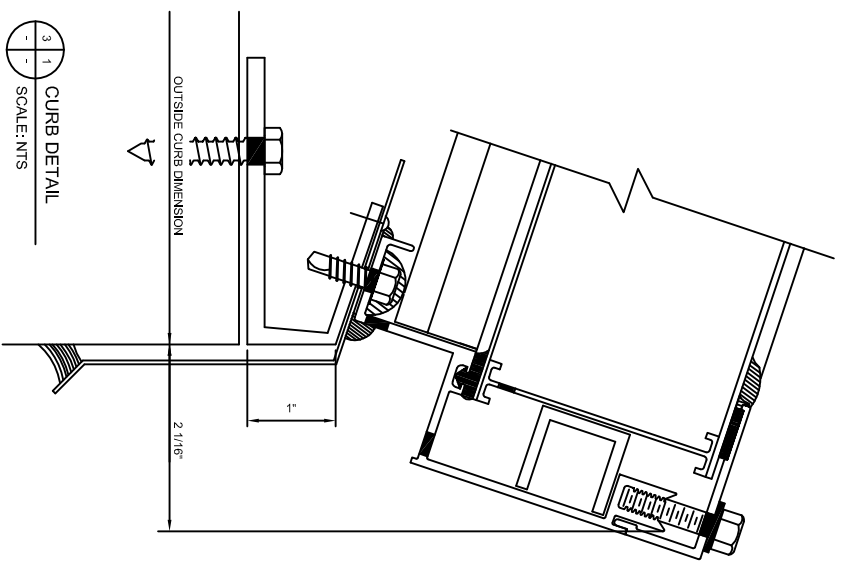

3
 CURB DETAIL
 SCALE: NTS

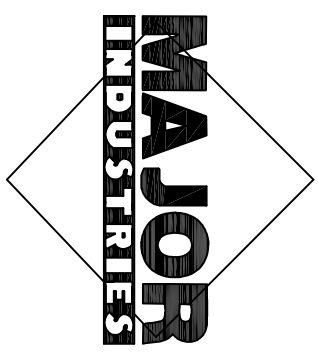

GUARDIAN 275®
 TRANSLUCENT PANEL
 SKYLIGHT SYSTEM

UNIT IS PICTURED
 WITH STANDARD
 GRID CORE.

THERMALLY BROKEN
 OPTION IS NOT
 SHOWN.

QS4-412PKD

MAJOR INDUSTRIES, INC.

7120 STEWART AVENUE
 WAUSAU, WI 54401
 PO BOX 306
 WAUSAU, WI 54402-0306

TELEPHONE:
 (715) 842-4616
 ENGINEERING FAX:
 (715) 843-5139

QUICKSHIP

4'-0" - 18 1/2° PYRAMID



MAJOR INDUSTRIES