

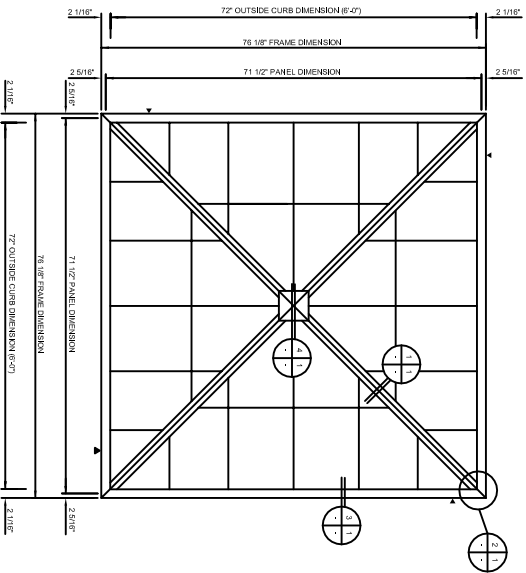

QUICKSHIP 6 FT - 18 1/2° PYRAMID

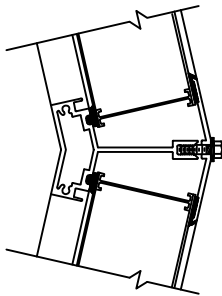

GUARDIAN 275
QUICKSHIP PYRAMID
TRANSLUCENT PANEL
SKYLIGHT SYSTEM



HIP DETAIL
SCALE: NTS

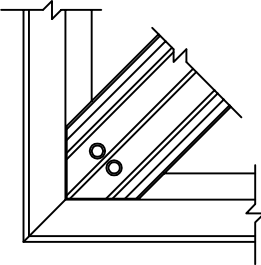

HIP CONNECTION
SCALE: NTS

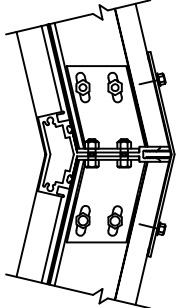

COMPRESSION CONNECTION
SCALE: NTS

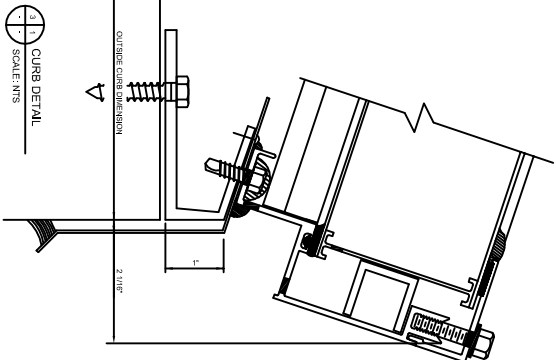

CURB DETAIL
SCALE: NTS

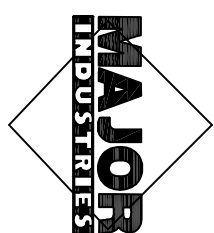

GUARDIAN 275[®]
TRANSLUCENT PANEL
SKYLIGHT SYSTEM

UNIT IS PICTURED
WITH STANDARD
GRID CORE.

THERMALLY BROKEN
OPTION IS NOT
SHOWN.

QS6-412PKD

MAJOR INDUSTRIES, INC.

7120 STEWART AVENUE
WAUSAU, WI 54401
PO BOX 306
WAUSAU, WI 54402-0306
TELEPHONE: (715) 842-4616
ENGINEERING FAX: (715) 843-5139

QUICKSHIP

6'-0" - 18 1/2° PYRAMID